

Autor: J. Anibal Voyer

Dificultad: 

Proporción: $h = \frac{1}{2} a$

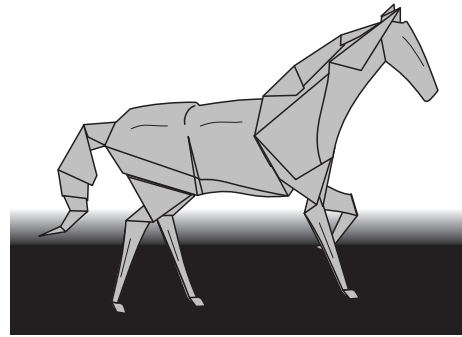

Caballo

1 

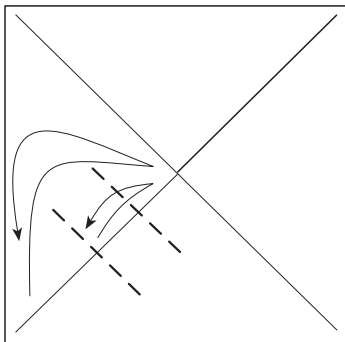

2

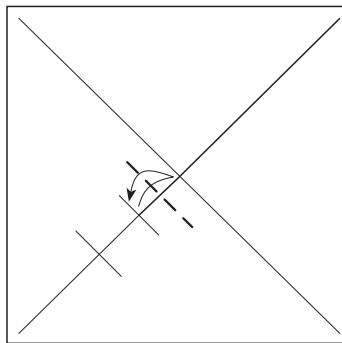

3

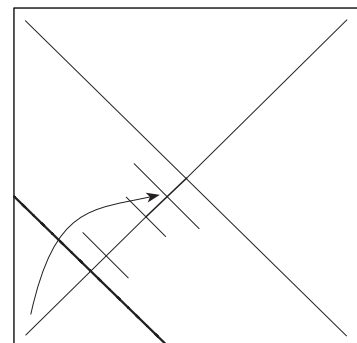

4

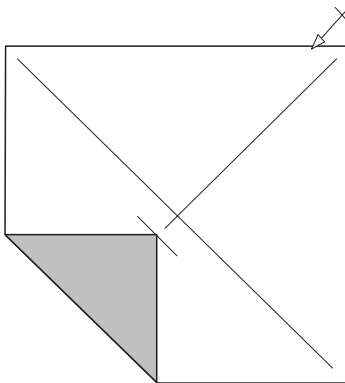

5

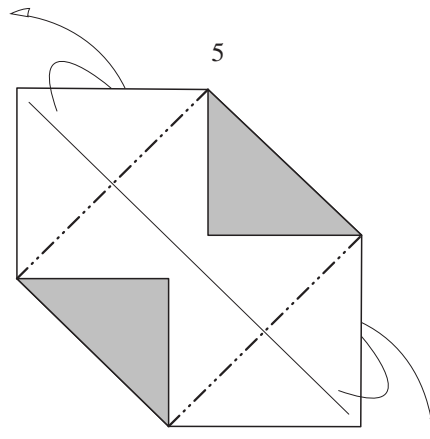

6

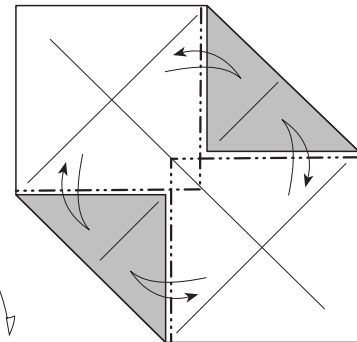

7

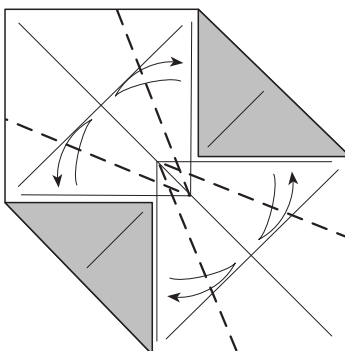

8

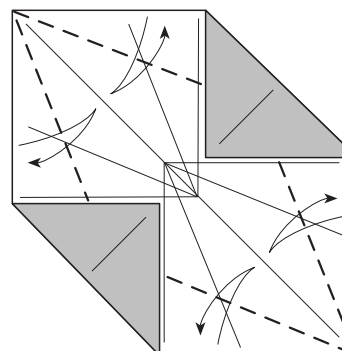

9

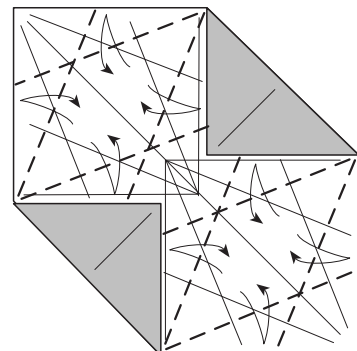

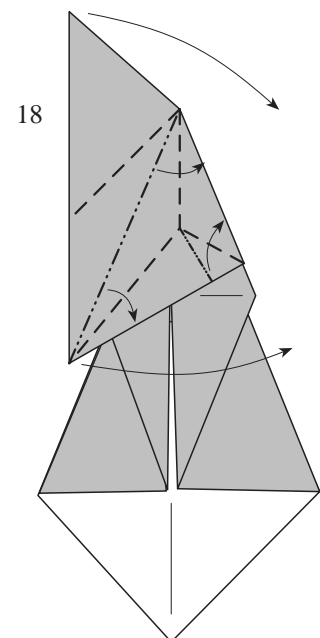
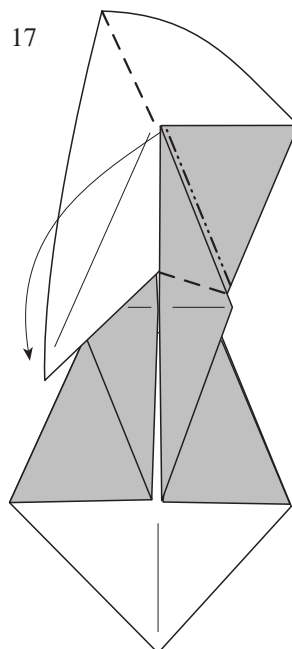
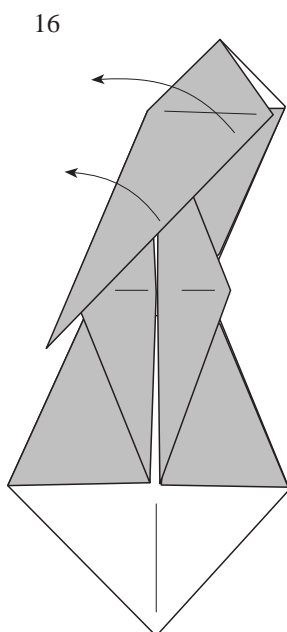
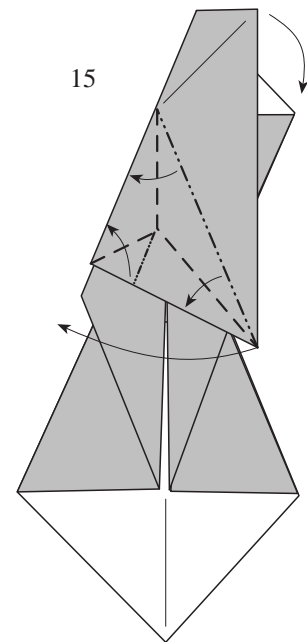
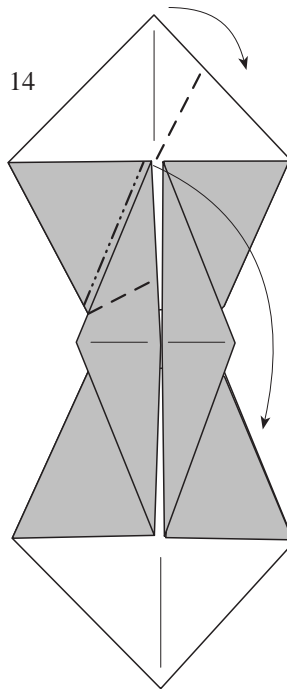
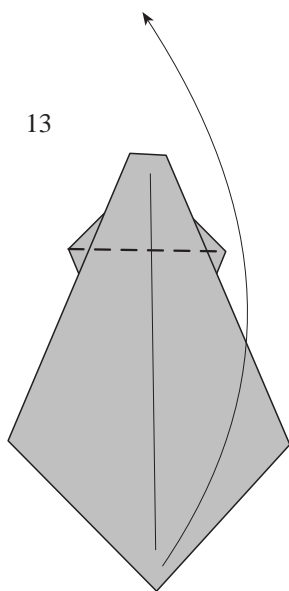
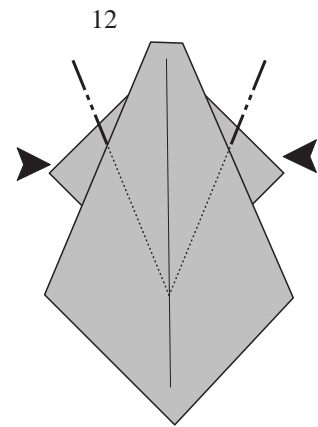
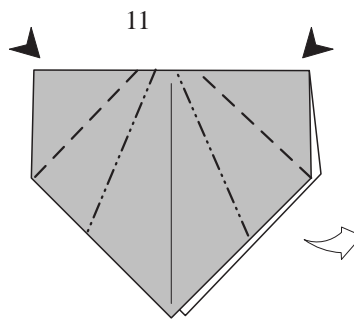
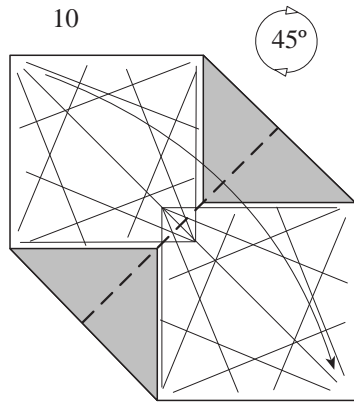

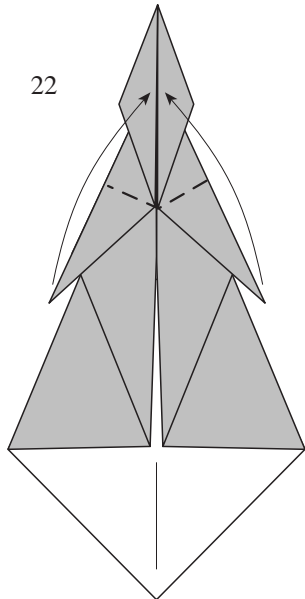
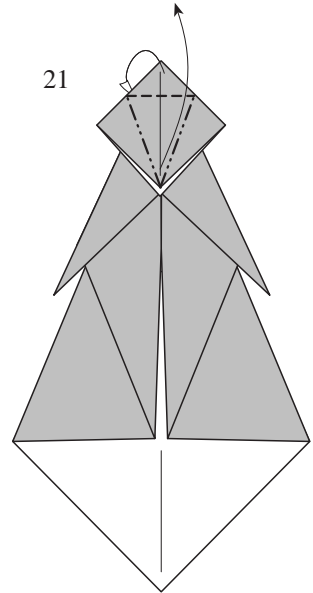
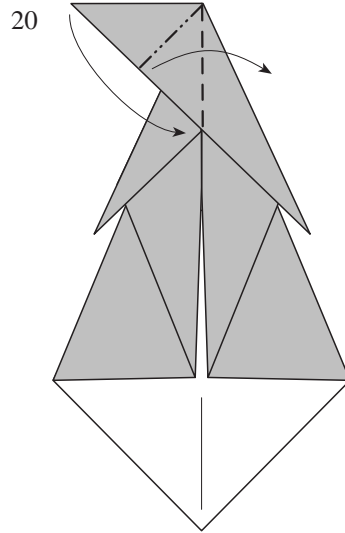
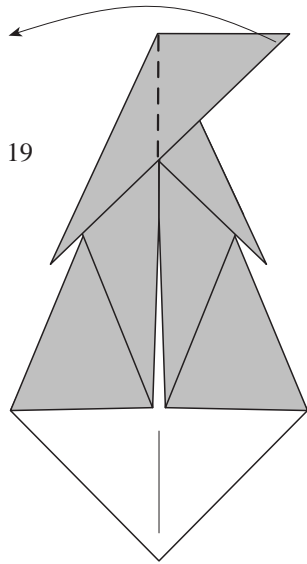

23 Repetir del
paso 14 al 20

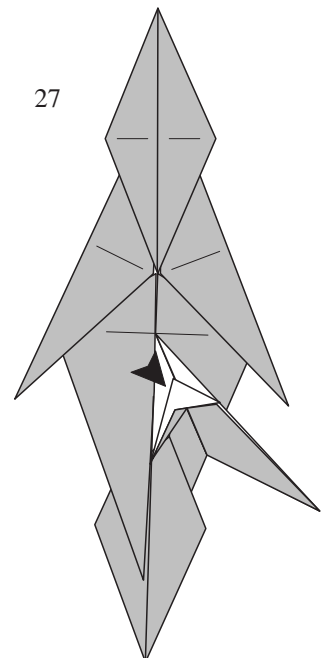
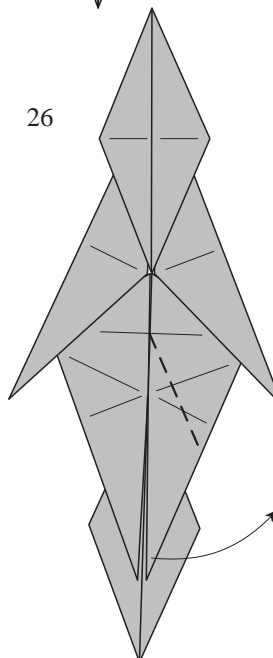
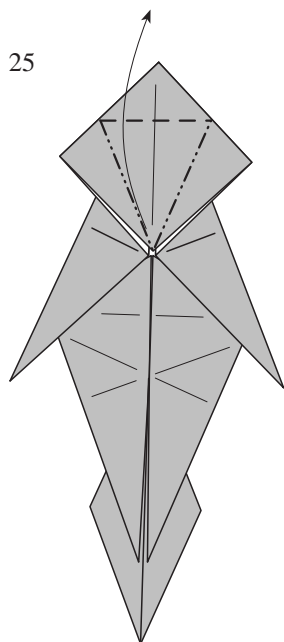
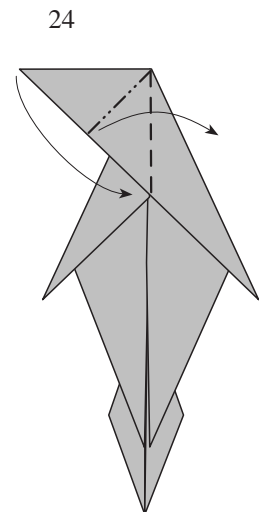
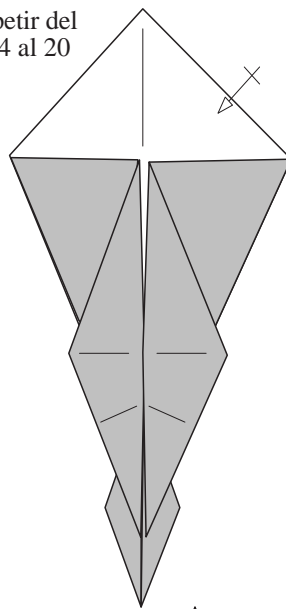

28 Repetir a la izquierda los pasos 26 y 27

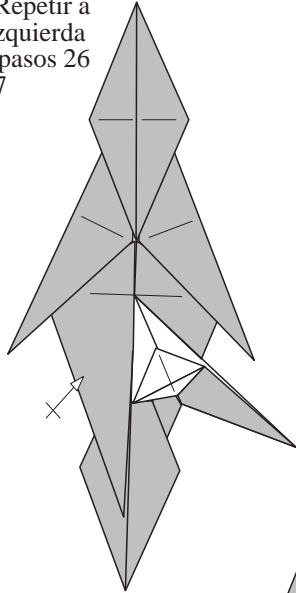

29

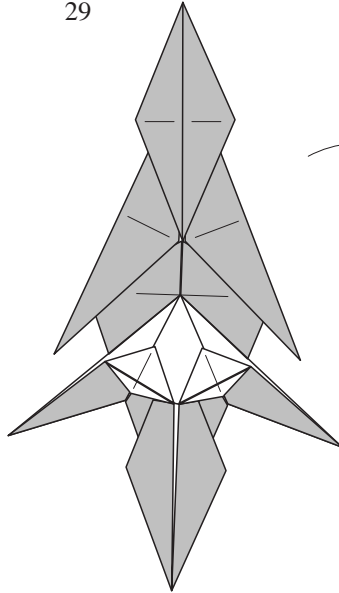

30

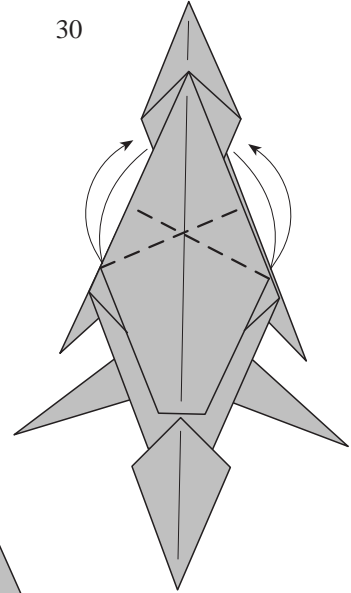

31 Este paso debe hacerse simultaneamente delante y detras

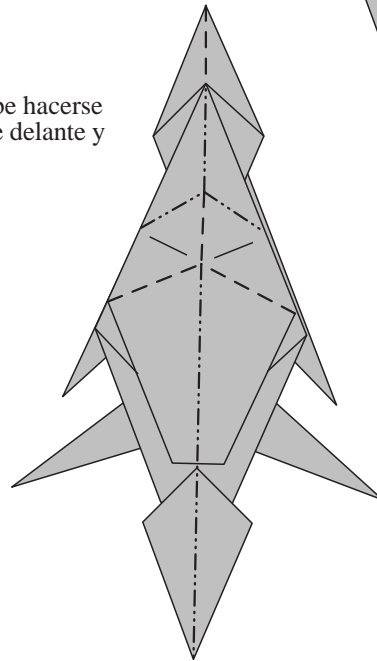
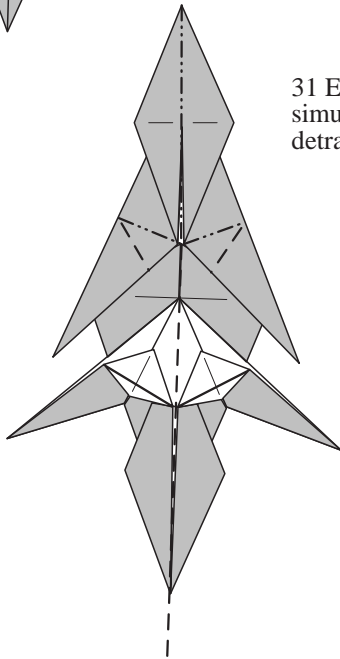

32

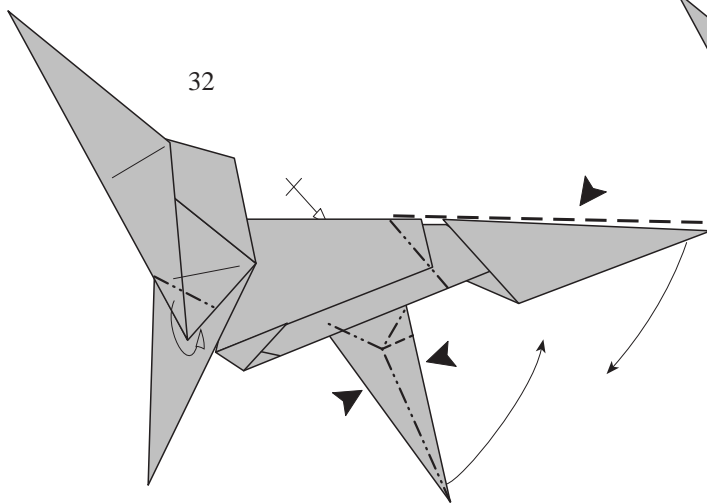

33

